

## Installation Guide

### Video Intercom System — Door Station

Model No. **VL-VQ1000SX**



Thank you for purchasing a Panasonic product.

Please follow all instructions in this document and save it for future reference.

Carefully read the information found in the section titled "Important safety information" in particular.

**The terms Door panel, Video doorbell, and outdoor station used in this document refer to the Door Station.**

This system is not designed to provide complete protection from property loss. To the maximum extent permitted by applicable law, Panasonic will not be held responsible for any damage incurred as a result of property loss.

#### Note to the installer

- Please read this document carefully, and install the product safely and correctly by following the instructions.
- Only use attachments/accessories specified by the manufacturer.
- The installation shall be carried out in accordance with all applicable installation rules.

## Important safety information

To prevent severe injury or loss of life or property, and to ensure proper and safe operation of your product, read this section carefully before using the product.



### WARNING

#### Preventing fire, electric shock, and short circuits

- **Leave installation work to the dealer. Installation work requires technical knowledge and experience. Electrical connection work should be performed by certified personnel only. Failure to observe this may cause fire, electric shock, injury, or damage to the product. Consult the dealer.**
- Do not disassemble or modify the product. Refer servicing to an authorized service center when service is required. Disassembling the product or manipulating the product in a way not described in the documentation may expose you to dangerous voltages and other risks.
- Never install wiring during a lightning storm.
- Do not connect non-specified devices.
- When opening holes in walls for installation or wiring, or when securing the cable, make sure you do not damage existing wiring and ductwork.
- Do not make any wiring connections when the power outlet is turned on.
- Do not install the product in the following places:
  - Places where the product may be splashed with water or chemicals
  - Places where there is a high concentration of dust or high humidity
- Do not expose the product to direct sunlight.
- Do not push any objects through the openings of the product.
- When existing wires are used, it is possible that they contain AC voltage. Contact an authorized service center.



### CAUTION

#### Preventing accidents, injuries, and property damage

- Do not use the product in unstable areas or areas prone to strong vibrations. This may cause the product to fall, resulting in damage to the product or injury.
- If the wiring passes outdoors, use a conduit and a surge protector.
- If the wiring passes underground, use a conduit, and do not make any connections underground.
- Install the product securely with screws according to the instructions in this document to prevent it from falling off the wall. Avoid installing onto low-strength walls, such as gypsum board, ALC (autoclaved lightweight concrete), concrete block, or veneer (less than 18 mm thick) walls.
- Do not put your ear(s) near the speaker, as loud sounds emitted from the speaker may cause hearing impairment.
- To prevent serious injuries due to the product unexpectedly falling, the product with a wall mount feature must be installed at a height of 2 m or lower.

## Privacy and rights of portrait

When installing or using the product, please take into consideration the rights of others with regard to privacy and rights of portrait.

- It is generally said that "privacy" means the ability of an individual or group to stop information about themselves from becoming known to people other than those whom they choose to give the information.

"Rights of portrait" means the right to be safe from having your own image taken and used indiscriminately without consent.

- Please observe the legal regulations (data protection, video surveillance) in your country during use.

## Data security

In order to use the system safely and correctly, the data security guidelines (listed below) must be observed.

Failure to do so may result in the following.

- Loss, leakage, falsification or theft of user information.
- Unauthorized or illegal use of the system by a third party.
- Interference or suspension of service caused by a third party.

### What is user information?

User information is defined as the following types of information.

- Information stored in the product
  - System event information
  - System and device settings
- Information stored on the computer that is used by the setup tool (CMS)
  - Resident names and room numbers
  - System and device settings

### Data security guidelines

- **Observe proper management of passwords.**
  - Passwords can be used to program the system, open doors, etc. Select passwords that are difficult to guess, change them regularly, and keep them secret. Assign a unique password to each device.
  - You will never receive inquiries about passwords from Panasonic.
- **Protect user information when sending the product to be repaired, or when handing it over to a third party.**
  - Use the product's reset function to initialize the product before when sending the product to be repaired or handing it over to a third party.
  - Note that user information may be deleted or initialized when the product is repaired.
  - Refer all repairs to a trusted Panasonic service center.
- **Protect user information stored on the computer used to configure the system.**
  - When user information is stored on a computer, the confidentiality of that information becomes the responsibility of the installer. Take precautions to prevent the unauthorized use of the computer and the setup tool (SCS and CMS) used for performing system configuration or maintenance.
  - Connect the computer to the network only when performing system configuration or maintenance, and disconnect the computer from the network as soon as the work is complete.
  - Use a secure network that is protected by a firewall, etc.
  - To prevent the leaking of personal information, enable a screensaver for the computer that uses a password.
  - Before disposing of the computer, ensure that data cannot be retrieved from it by formatting the hard disk and/or rendering it physically unusable.
- **Protect user information when disposing of the product.**
  - Use the product's reset function to initialize the product before disposing of the product.

## Disclaimer

- Recorded data may be altered or deleted as a result of incorrect operations, exposure to static electricity, accidents, malfunction, repairs or other operations.  
To the maximum extent permitted by applicable law, Panasonic assumes no liability for any direct or indirect damages resulting from the loss or alteration of recorded data.
- To the maximum extent permitted by applicable law, Panasonic assumes no responsibility for injuries or property damage resulting from failures arising out of improper installation or operation inconsistent with this document.
- To the maximum extent permitted by applicable law, Panasonic will not be held responsible for any damage or loss due to non-performance or delay in performance, error or failure of network and/or any products.

## Other important information

- Before attempting to connect or operate this product, please read the nameplate on the bottom or rear of the product.
- If you stop using this product, remove it from the walls to prevent it from falling off.
- When power fails, this product cannot be used.
- Panasonic may not be liable for damages due to external factors such as power failures.

## General information

- In the event of problems, you should contact your equipment supplier in the first instance.
- After removing the product and any included items from the packaging, store, dispose, or recycle the packaging as necessary. Note that certain types of packaging may be a suffocation or choking hazard.

## Cleaning





Wipe the product with a soft, dry cloth.

- For excessive dirt, wipe the product with a cloth slightly dampened with fresh water.
- When the product is installed near ocean coasts, wipe the product with a cloth slightly dampened with fresh water once every 2 to 3 months.

### Important:

- **DO NOT USE ANY SOLVENTS CONTAINING CHLORINE. This causes the product to rust.**
- **Do not use any cleaning products that contain alcohol, polish powder, powder soap, benzene, thinner, wax, petroleum, or boiling water. Also do not spray the product with insecticide, glass cleaner, hair spray or wall paint. This may cause a change in color or quality of the product.**

## Graphical symbols for use on equipment and their descriptions

Symbol	Explanation
	Alternating current (A.C.)
	Direct current (D.C.)
	Caution: risk caused by visible radiation
	For indoor use only
	Class II equipment (equipment in which protection against electric shock relies on Double Insulation or Reinforced Insulation)

## Terms and illustrations

- Design and specifications are subject to change without notice.
- Illustrations may vary slightly from the actual product.

# 1. Name and Function of Each Part

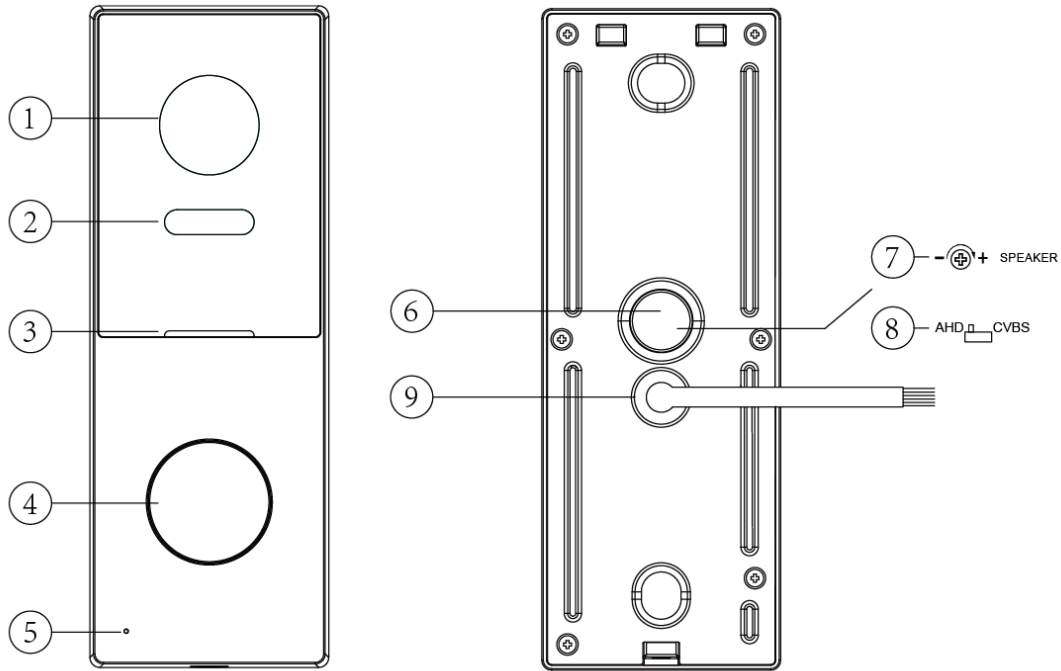

NO.	Part Name	NO.	Part Name
1	Camera	6	Cover for the switches
2	LED for night vision	7	SPEAKER volume adjust <sup>*1</sup>
3	Speaker	8	AHD/CVBS switch <sup>*2</sup>
4	Call button	9	Wires for monitor/electric lock
5	Microphone		

\*1 There's a rubber on the door station backside, you can check the knob inside. If you need to increase the volume came from the other side during an intercom call, turn the volume adjustment knob clockwise to make the sound louder. Conversely, turning it counterclockwise will decrease the sound.

\*2 Normally the Door Station has two standards: CVBS and AHD (1080P), to ensure that Door Station and Room Monitor could establish regular image, Room Monitor needs to set corresponding standard in the "Engineering Setting">"Set Video Door Bell Resolution": There's a rubber on the Door Station backside, you can check the switch inside (left is AHD, right is CVBS), which can switch different standards. If you choose CVBS, the Room Monitor side need to choose. If you choose AHD, Room Monitor side needs to choose 1080P. Also, the default setting will be AHD on Door Station side, 1080P on Room Monitor side.

## 2. Features

- High quality aluminum alloy housing: IP65, IK07
- Color HD CMOS camera: 1920 x 1080
- Viewing angle: H120° V62° D145°
- White LED for night vision
- Speaker volume adjustable
- Door lock release
- 4 Wires in polarity
- Surface mounted, corner bracket available
- Operation temperature: -10 °C to +55 °C
- Dimensions (mm): Approx. 133(H) x 48(W) x 21(D)
- Mass (Weight): Approx. 190 g

## 3. Packing Contents

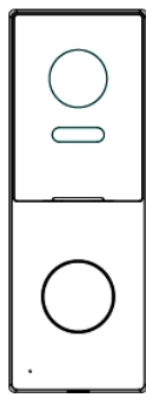

Main body

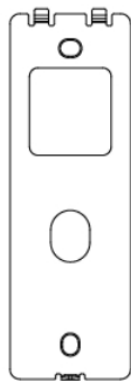

Flat installation  
wall bracket

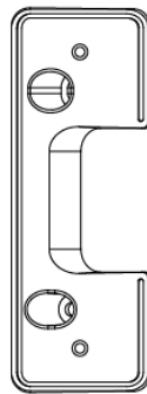

Angle installation  
wall bracket

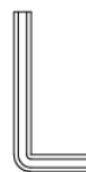

Hex wrench

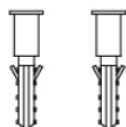

Plastic expansion pipe  
(4 mm x 35 mm)



Screw  
(4 mm x 35 mm)







Screw  
(4 mm x 8 mm)



Hex screw  
(3 mm x 6 mm)

## Plastic packaging materials information for this product

Plastic packaging material	Recycling mark	Thickness	Importer EPR number
Bag for Main body		50 Microns or more	Panasonic Life Solutions India Pvt. Ltd. EPR number : 2023030608544812298
Protective film for Main body		50 Microns or more	
Bag for Angle installation wall bracket		50 Microns or more	
Bag for Screw / Expansion pipe		50 Microns or more	
Bag for Screw / Wrench		50 Microns or more	

This information is prepared in accordance with India / Plastic Waste Management (Amendment) Rules

## 4. Connection Diagram

### 4.1 Wiring Diagram

Please be careful to wiring on polarity.

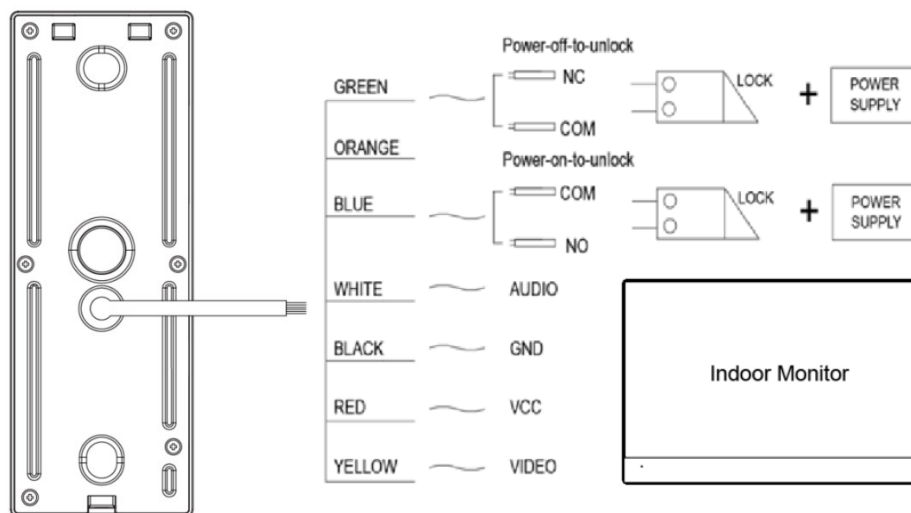

### 4.2 Electric Lock Connection

Note:

1. The external power supply must be used according to the lock.
2. The inside relay contact is restricted to DC 3 A/30 V.
3. There are two unlock types as the follows:

Type 1: Power-on-to-unlock

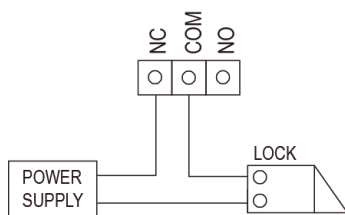

Type 2: Power-off-to-unlock

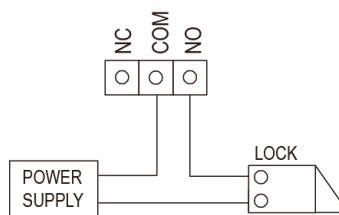

# 5. Installation

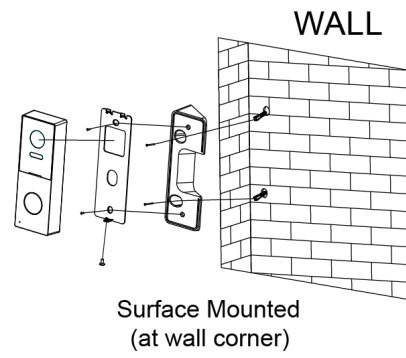
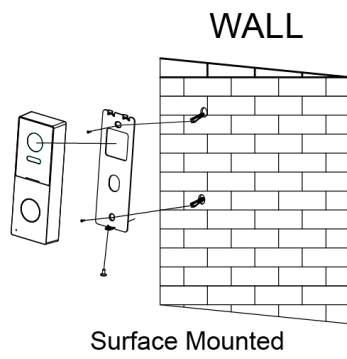
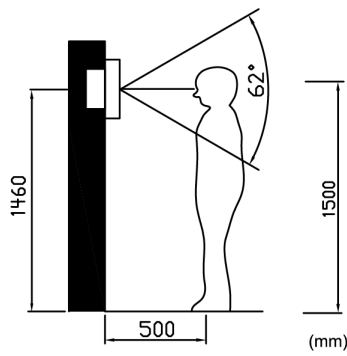

## Camera installation location

Standard installation height of outdoor station: lens's height is about 1,500 mm above the floor; in this case, installation wall bracket center is about 1,460 mm above ground level.

**Panasonic Corporation**

1006 Kadoma, Kadoma City, Osaka 571-8501, Japan

<https://www.panasonic.com>

© Panasonic Corporation 2026

**PNQP2039ZA P0126MG0**